

MINIATURE

Lampholders

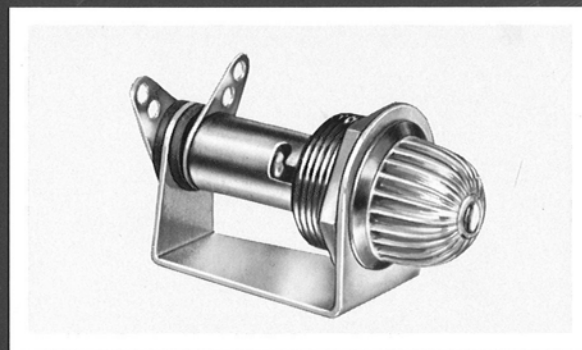

CATALOG 400

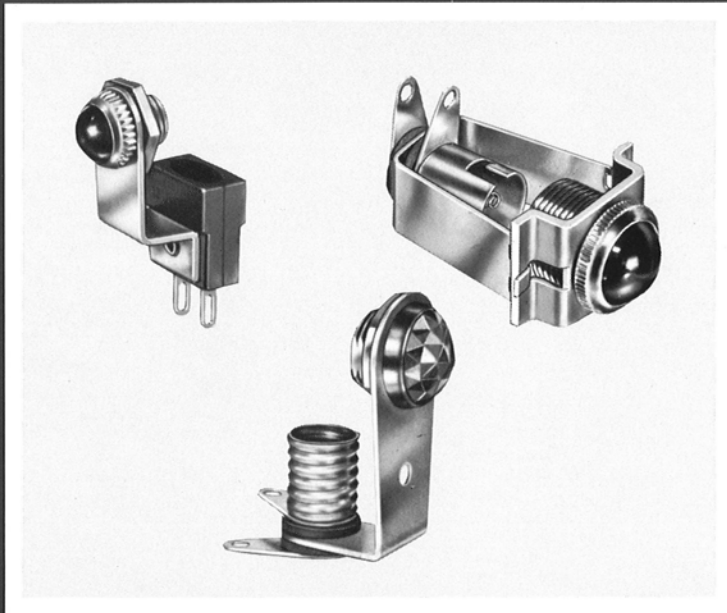

Complete Line of

LAMP HOLDERS
AND
TERMINAL BOARD
ASSEMBLIES



AERONAUTICAL ELECTRIC COMPANY



Electronic Components

division of ACO, Inc.

5656 NORTHWEST HIGHWAY, CHICAGO, IL 60646
PHONE 773 774-5200



TERMINAL BOARD

ACO offers a variety of material combination, electronic hardware and the latest in assembly techniques. Boards can be supplied with imprinting and wax or varnish impregnation.

Special terminal board assemblies fabricated to your specifications. For quotation submit samples or drawings.

STANDOFF TYPE TERMINAL BOARDS

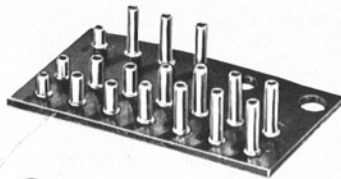

TUBE PINS



THREADED STANDOFF
TERMINALS (COLD HEADED)

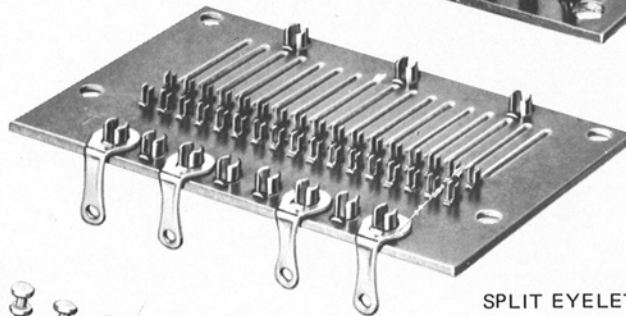
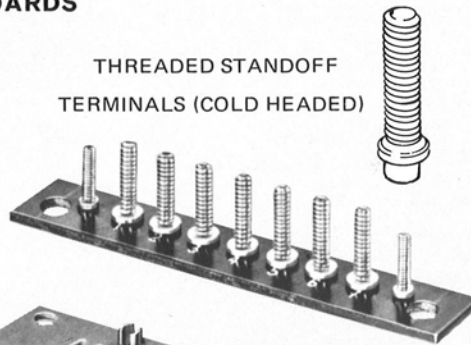

SPLIT EYELETS

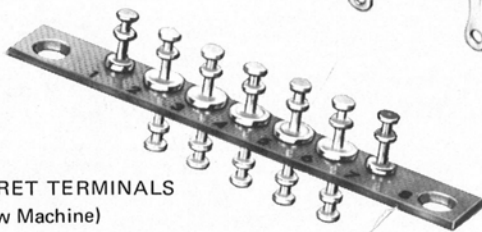

TURRET TERMINALS
(Screw Machine)
Single or Double End

BATTERY CONNECTOR ASSEMBLIES

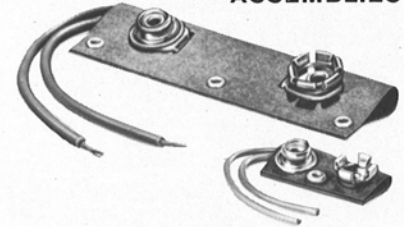

STRAIN RELIEF WIRE CLAMPS with "S" hook

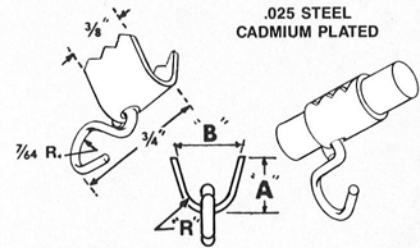

PART NUMBER	"A"	"B"	"R"
15668-1	1/4"	17/64"	7/64
15668-2	21/64"	17/64"	7/64
15668-3	7/16"	11/32	7/64
15668-4	3/8"	27/64	5/32

FEED THRU TERMINAL BOARDS

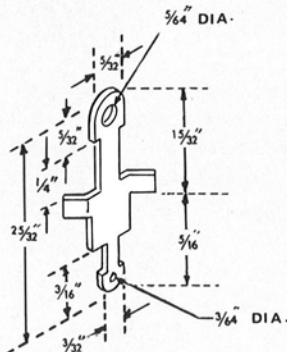
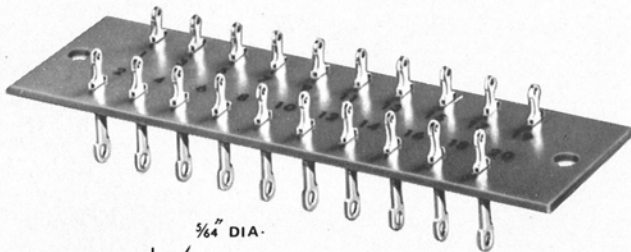

.025 BRASS
CADMIUM PLATED

No. 20
TERMINAL

CUSTOM BINDING POST ASSEMBLIES

Screw Terminal

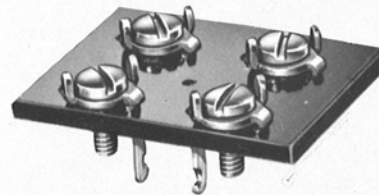

.050 BRSS, HOT TIN
8-32 x 3/8" B.H. SCREW
NICKEL PLATED

No. 70

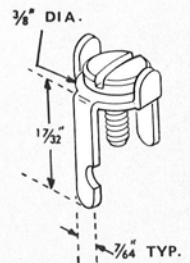

CUSTOM DRAWN-LUG ASSEMBLIES

No. 952
TERMINAL

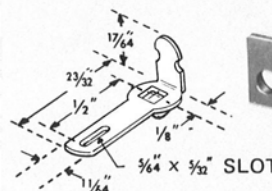

.025 BRASS
CADMIUM PLATED

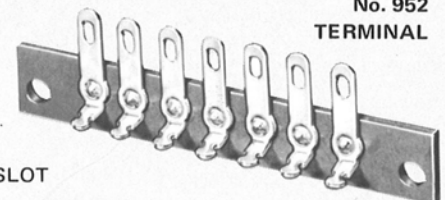

ASSEMBLIES



MINIATURE TERMINAL STRIPS ($\frac{1}{4}$ " Spacing)

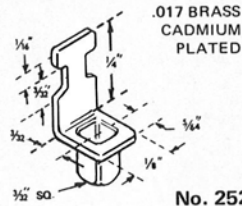
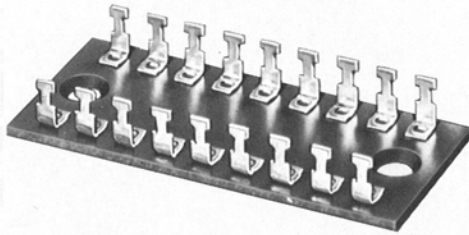

No. 252
TERMINAL

.017 BRASS
CADMIUM
PLATED

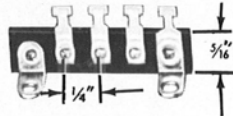

No. 251
TERMINAL

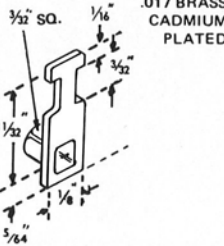

.017 BRASS
CADMIUM
PLATED

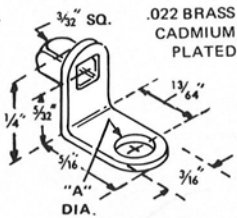
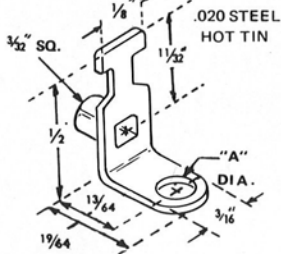

BRACKET NO.	"A"
2093	.093
2127	.127

BRACKET NO.	"A"
2093	.093
2127	.127

Wax impregnation available when specified

TERMINAL STRIPS ($\frac{3}{8}$ " Spacing)

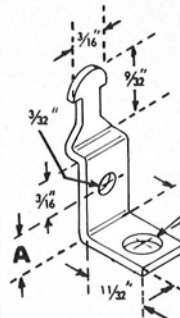

BRACKET NO.	DIM "A"
11-6	$\frac{7}{32}$ "
17-6	$\frac{5}{16}$ "
18-6	$\frac{7}{16}$ "

CLEARANCE FOR
#2-32 SCREW

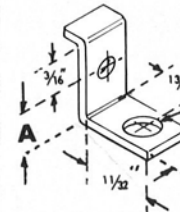

BRACKET NO.	DIM "A"
110-6	$\frac{3}{16}$ "
113-6	$\frac{5}{16}$ "
111-6	$\frac{7}{16}$ "

No. 843
TERMINAL

.023 BRASS
CADMIUM PLATE

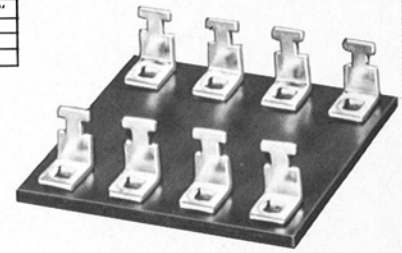
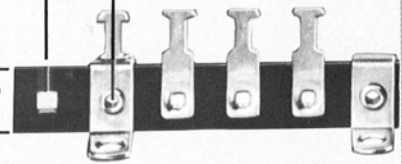
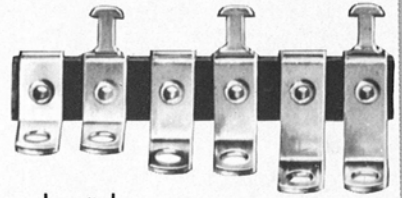

Wax impregnation available when specified

No. 32 LUG

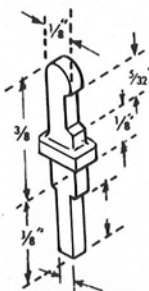

COPPER-LUG TERMINAL BOARDS

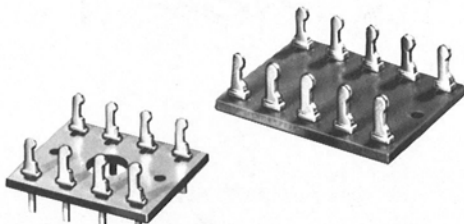

.050/.060 COPPER—HOT TIN

No. 30 LUG

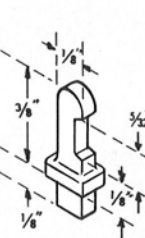

BINDING POST ASSEMBLIES

Screw Terminal

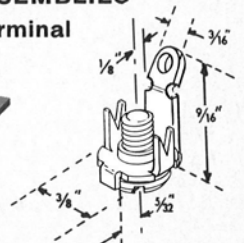
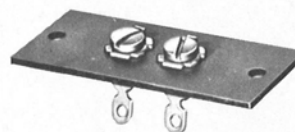

1/32" BRASS—CADMIUM PLATED
6-32 x 3/8" B. H. SCREW

No. 149 TERMINAL

CONNECTOR PLUG AND SOCKET ASSEMBLIES

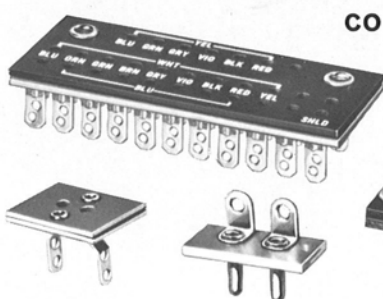

.016 BRASS
CADMIUM
PLATED

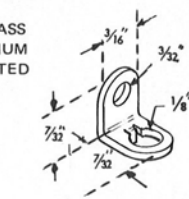

No. 19 TERMINAL

CONICAL TERMINAL BOARD ASSEMBLIES

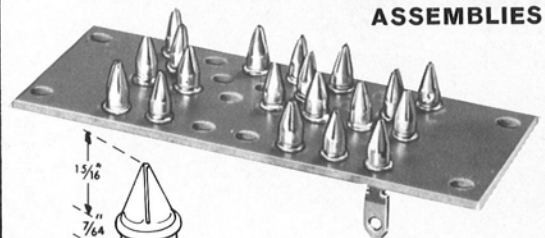

No. 200 TERMINAL



LAMPHOLDER INDICATOR LIGHTS

FOR T-3¹/₄ NEON GLOW LAMP WITH BUILT-IN RESISTOR

85 SERIES

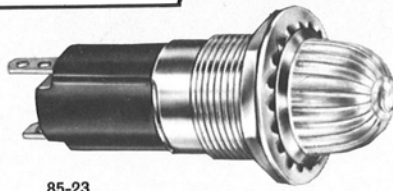

85-23

75W-125V

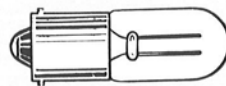

T-3-1/4
MINIATURE
BAYONET BASE

Requires 11/16" mounting hole

Used with standard NE-51 lamp or high brightness neon glow lamp NE-51H. Assemblies made for the NE-51 neon lamp have 100,000 ohm resistors and those made for the NE-51H have 27,000 ohm resistors.

FOR LOW VOLTAGE INCANDESCENT LAMP

86 SERIES

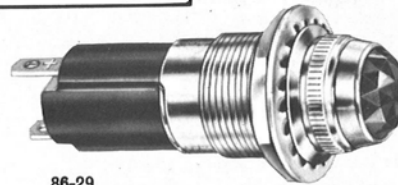

86-29
WITHOUT RESISTOR

6 TO 28V

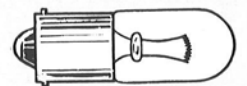

T-3-1/4
MINIATURE
BAYONET BASE

Requires 11/16" mounting hole

LENS TYPES FOR SERIES 85 AND 86

5/8" Plastic or Glass Dome Type Lens (fluted or smooth) with 180° visibility.

1/2" Plastic or Glass Type Lens (faceted or smooth-convex) mounted in a brass, nickel finished lens holder.

LENS COLOR

Red—Green—Amber—Blue—White (Translucent)—Clear (Colorless).

NOTE: Green and Blue not recommended with Neon Lamps.

FOR T-1³/₄ or G2 SUB-MINIATURE MIDGET SCREW BASE LAMP

90 SERIES



7V-14V-28V



T-1-3/4
MIDGET SCREW BASE LAMP
(Incandescent)

Requires 7/16" mounting hole

MOUNTING BUSHING:

Brass, nickel finish, 7/16"-32 Thd. Requires 7/16" mounting hole.

SOLDER OR QUICK-DISCONNECT TERMINALS:

Brass, tin plated with elongated slots, tapered to accept AMP No. 98 taper-tab receptacles.

INSULATION:

Housing, glass reinforced polyester.

LOCKWASHER & HEX NUT:

Steel, nickel finish.

LENS COLOR:

Red—Green—Yellow (Amber)—Blue—White.

LENS SHAPE:

Dome or Cylindrical.

NOTE:

Supplied with lamp installed.

ASSEMBLIES



MINIATURE BAYONET AND SCREW OPEN TYPE ASSEMBLIES FOR LOW VOLTAGE INCANDESCENT LAMPS

VERTICAL OPEN TYPE FOR 1/2" LENS • Requires 7/16" mounting hole

72 SERIES

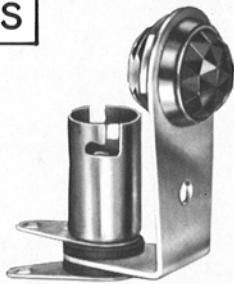
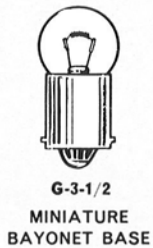

72-139-14

73 SERIES



T-3-1/4
MINIATURE
BAYONET
BASE



73-138-14

74 SERIES



T-3-1/4
MINIATURE
SCREW
BASE

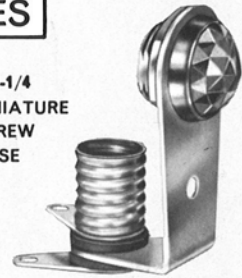

74-139-14

LENS TYPE; FACETED OR SMOOTH CONVEX

NOTE: Lamp replacement from rear of panel only

HORIZONTAL OPEN FOR T-3 1/4 LAMP • Requires 11/16" mounting hole

75 SERIES

LENS TYPE
3/8" Plastic or Glass
Dome Type Lens (fluted
or smooth).
1/2" Plastic or Glass
Type Lens (faceted
or smooth convex)
mounted in solid brass
knurled lens holder.

NOTE: Lamp replace-
ment from front of
panel.

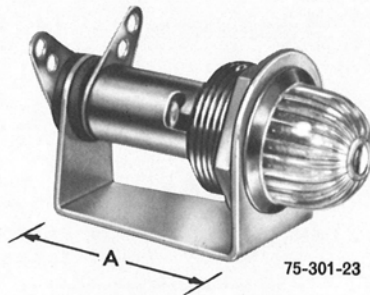

75-301-23

77 SERIES

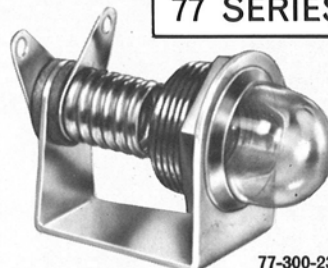

77-300-23

78 SERIES

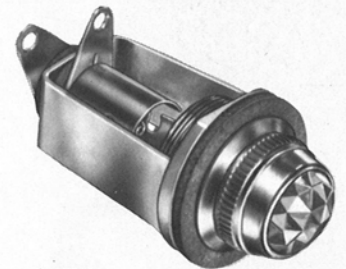

78-169-29

ACO PART NUMBER	PANEL THICKNESS	A DIM.	LENS DIA.
75-301-23	0 TO 15/64"	1-9/32"	5/8"
75-300-23	1/4"	1-5/32"	5/8"
75-302-29	0 TO 7/64"	1-11/32"	1/2"
75-301-29	1/8" TO 15/64"	1-9/32"	1/2"
75-300-29	1/4"	1-5/32"	1/2"

DETACHABLE TYPE SOCKET

79 SERIES

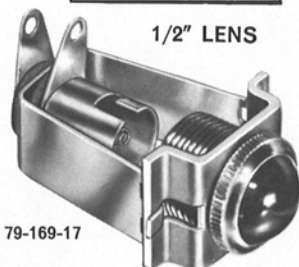

79-169-17

Available with wire leads.
Requires 9/16" mounting hole.
NOTE: Bracket snaps off formed
nut for easy lamp replacement.

VERTICAL OPEN FOR 11/32" LENS • 5/16" mounting hole

80 SERIES

FOR G-3-1/2
MINIATURE
BAYONET
BASE LAMP

80-137-11



81 SERIES

FOR T-3-1/4
MINIATURE
BAYONET
BASE LAMP

81-136-11

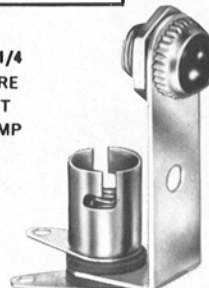

82 SERIES

FOR T-3-1/4
MINIATURE
SCREW BASE
LAMP

82-137-11



LENS TYPE; FACETED OR SMOOTH CONVEX

NOTE: Lamp replacement from rear of panel only



LAMPHOLDER

LENS ASSEMBLIES SCREW TYPE

1" LENS ASSEMBLIES NO. 20



FLAT

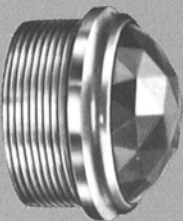

FACETED



CONVEX

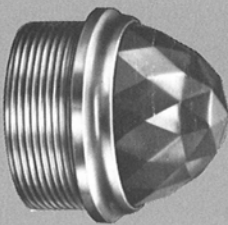

TORPEDO FACETED

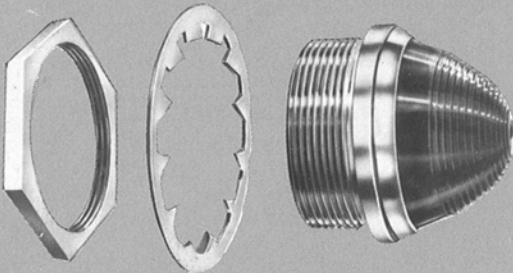

TORPEDO BEEHIVE

1"-27 THREAD
3/8" SHANK

NO. 11

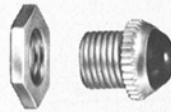

11/32" LENS
5/16"-32 THREAD
1/4" SHANK

NO. 14

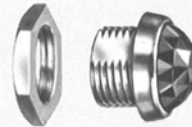

1/2" LENS
7/16"-27 THREAD
1/4" SHANK (OPTIONAL 3/8")

NO. 17

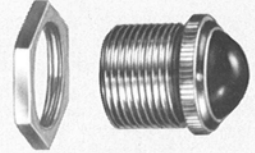

1/2" LENS
9/16"-27 THREAD
7/16" SHANK

NO. 19

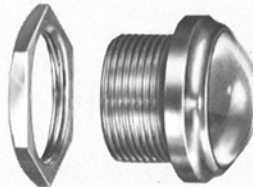

3/4" LENS
11/16"-27 THREAD
3/8" SHANK

NO. 35



ANODIZED
ALUMINUM

11/32" LENS
9/16"-27 THREAD
1/4" SHANK

SCREW TYPE

NO. 23



5/8" PLASTIC DOME (SMOOTH)
9/16"-27 THREAD | 3/16" SHANK

NO. 23

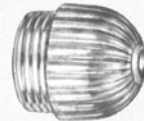

5/8" PLASTIC DOME (FLUTED)
9/16"-27 THREAD | 3/16" SHANK

NO. 29



1/2" LENS
9/16"-27 THREAD | 3/16" SHANK

NO. 32



5/8" GLASS DOME
9/16"-27 THREAD | 3/16" SHANK

THE ABOVE FOUR LENS ASSEMBLIES ARE RECOMMENDED FOR THE
AERONAUTICAL SERIES 85 & 86 CUSTOM MOLDED INDICATOR
LIGHTS AND OPEN HORIZONTAL SERIES 75-77-78.

LENS COLORS:

Red — Green — Amber — Blue — White
(translucent) — Clear (colorless)

LENS MATERIAL:

Glass, Lexan, or Acrylic.

METAL FINISHES:

Lens Holders are nickel or bright
chrome plated.
Other finishes may be had on special order.

ASSEMBLIES



OPEN TYPE ASSEMBLIES VERTICAL

FOR C-7 AND S-6 LAMPS

Designed for applications on circuits and where lamp replacement is accessible from the rear of the panel making assembly TAMPER PROOF.

WIRE LEADS CUT TO YOUR SPECIFICATIONS

DOUBLE CONTACT CANDELABRA BAYONET

Recognized under the Component Program of Underwriters Laboratories, Inc.

Candelabra bayonet assembly with wire leads is designed for use with the 10C7DC Lamp having a long life rating of 3000 hours.

1" LENS

REQUIRES 1" MOUNTING HOLE



SINGLE CONTACT CANDELABRA BAYONET

Candelabra bayonet with wire lead ground lug optional.

1" LENS

**REQUIRES
1" MOUNTING
HOLE**

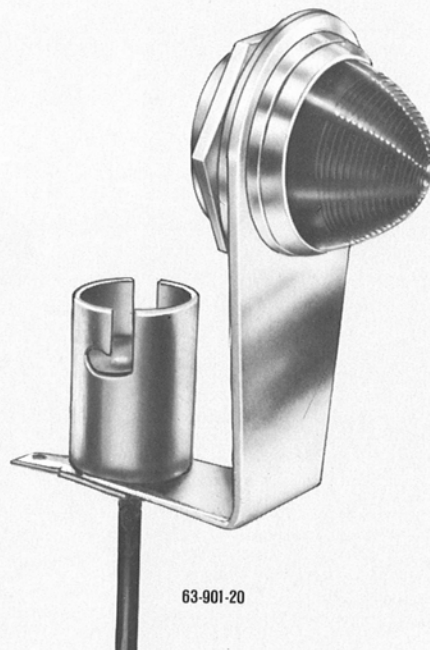

PRINTED DISCS

These sockets can be furnished with a disc inserted under a FLAT lens having a word, trade mark, numeral or letter.

A choice of colored unfrosted lenses are available. White translucent lens should not be used with a disc, instead a clear (colorless) lens with a white disc permits the legend to be visible.

TYPE N



**NEGATIVE DISC
BLACK BACKGROUND
ILLUMINATED LETTERS**

TYPE P



**POSITIVE DISC
BLACK LETTERS
ILLUMINATED BACKGROUND**

CANDELABRA SCREW BASE

83 SERIES

Open type with
Solder Lugs.

3/4" LENS

**REQUIRES
11/16" MOUNTING
HOLE**

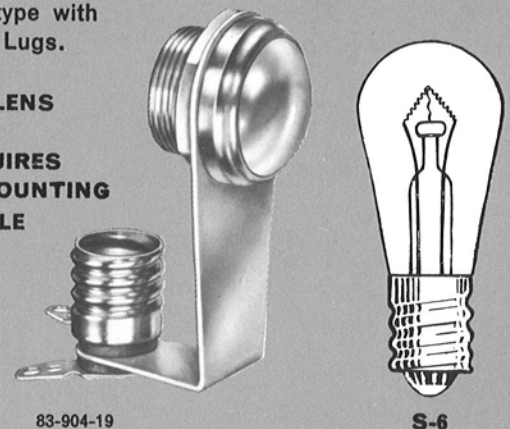



LAMPHOLDER

MINIATURE WEDGE BASE 40 SERIES LAMP HOLDERS

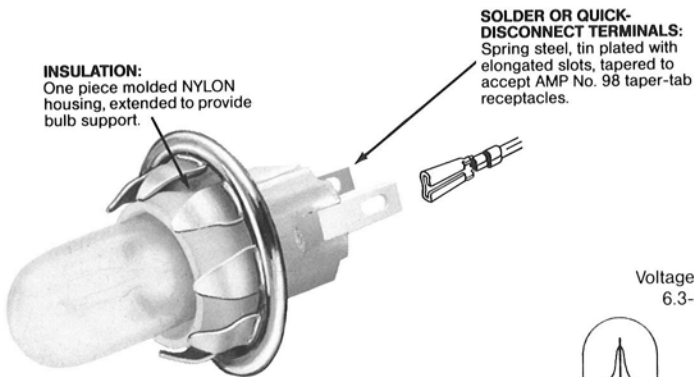

Voltage Range
6.3-14V

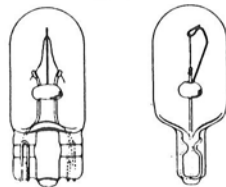

T-3/4 or T-5 wedge base lamp

40-730 SERIES

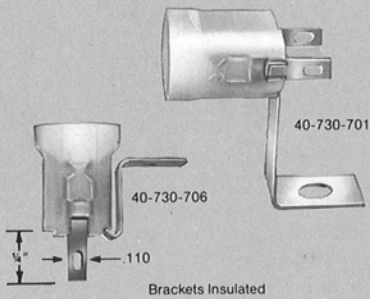

40-732 SERIES

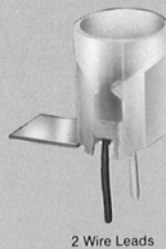

40-735 SERIES

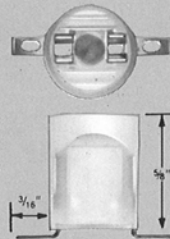

Printed Circuit Lampholders

40-733 SERIES

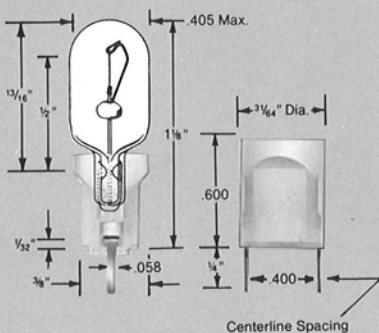

40-734 SERIES

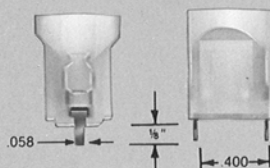

MINIATURE TWO PIN LAMP HOLDERS



G-3-1/2

35 SERIES

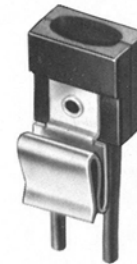

35-600-D

36 SERIES



36-1392

37 SERIES

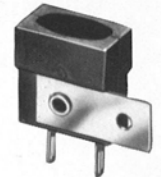

37-603-R

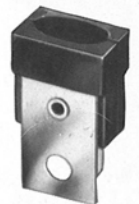

37-605-D

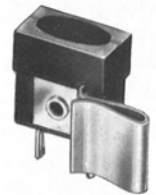

37-601-R

TWO PIN INDICATOR LIGHTS

11/32" LENS

REQUIRES 5/16" MOUNTING HOLE

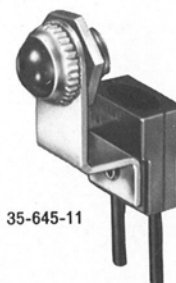

35-645-11

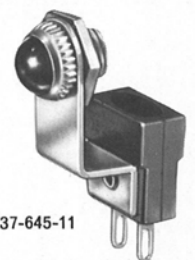

37-645-11

LENS COLOR:
Red—Green—Amber—Blue—
White (Translucent)—Clear (Colorless).

LENS HOLDER:
No. 11—Nickel finish.

ASSEMBLIES



MINIATURE BAYONET SOCKETS WITH WIRE LEADS FOR LOW VOLTAGE INCANDESCENT LAMPS

Important feature on this new design using a sleeve molded from nylon material makes this socket completely insulated and unbreakable.

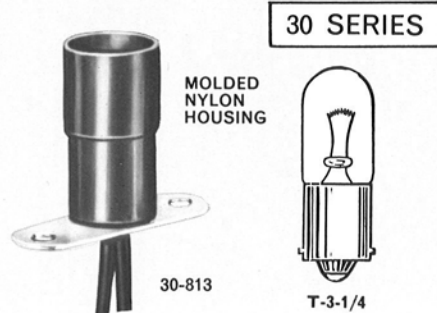

GROUNDING SOCKETS ONE WIRE LEAD

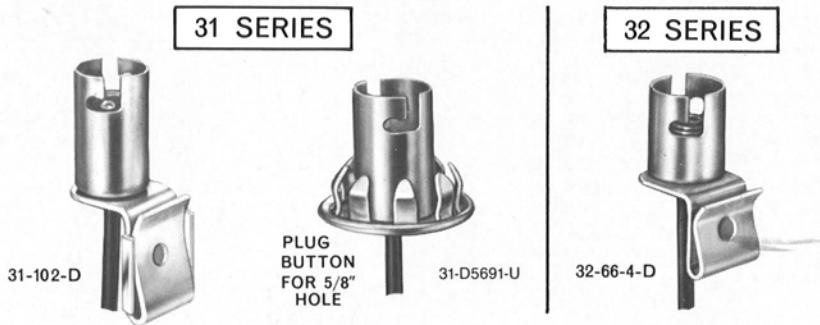

GROUNDING SOCKETS TWO WIRE LEADS

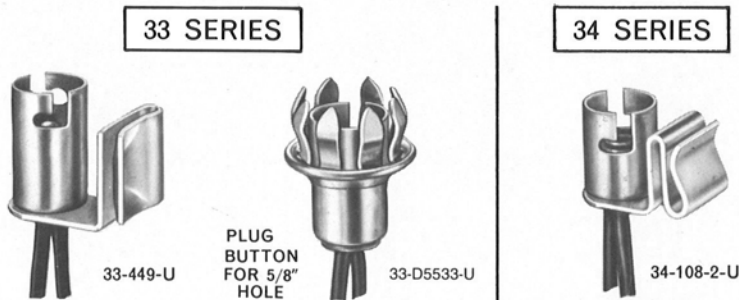

SINGLE CONTACT CANDELABRA BAYONET

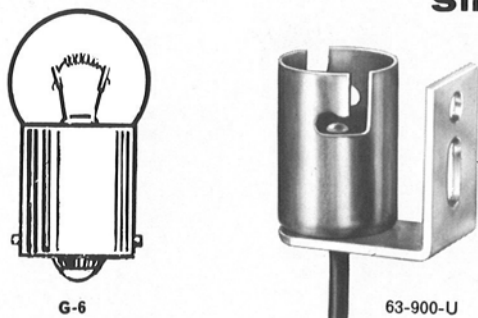

DOUBLE CONTACT CANDELABRA BAYONET

Recognized under the Component Program of Underwriters Laboratories, Inc.

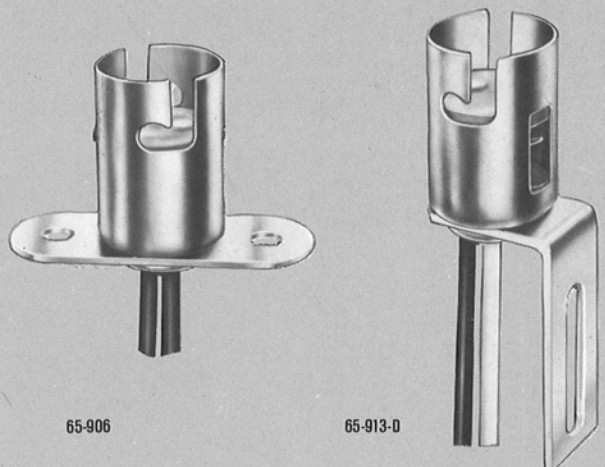
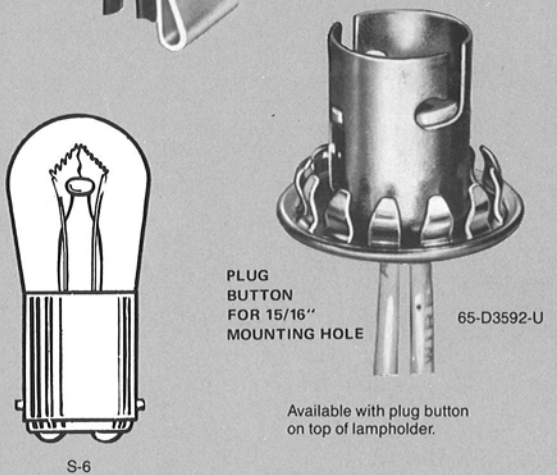
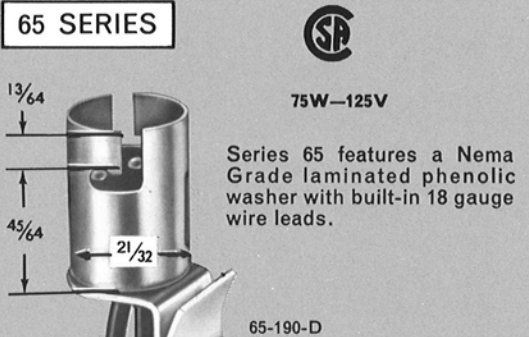

Above sockets using double contact candelabra bayonet base shell Part #5020



LAMPHOLDER OPEN TYPE ASSEMBLIES

FOR LOW VOLTAGE INCANDESCENT LAMPS 6 TO 28V

MINIATURE SCREW BASE LAMPS

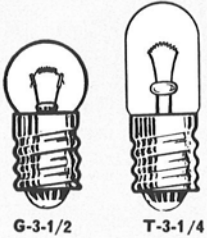

MINIATURE SCREW SOCKETS

10 SERIES



10-50A

TWO LUGS

Above sockets using miniature screw base shell Part #5050

11 SERIES



11-66-4-U

GROUNDED

12 SERIES

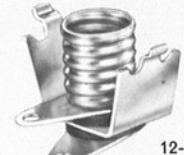

12-141-U

INSULATED

Miniature bayonet
base shell
Part #5001

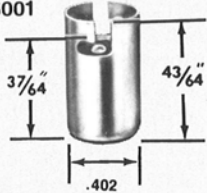

MINIATURE BAYONET BASE LAMPS

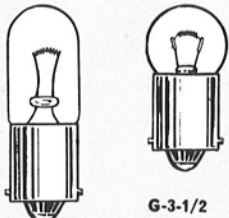

G-3-1/2

T-3-1/4

Miniature bayonet
base shell
Part #5010

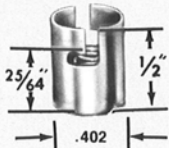

MINIATURE BAYONET SOCKETS

13 SERIES

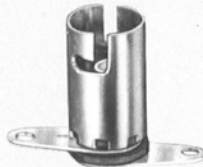

13-50A

TWO LUGS

14 SERIES

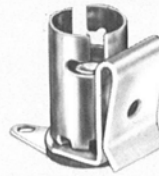

14-104-U

GROUNDED

15 SERIES

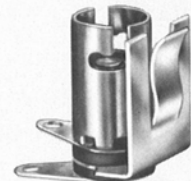

15-546-U

INSULATED

16 SERIES



16-50A

TWO LUGS

17 SERIES

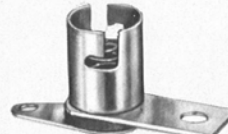

17-130

GROUNDED

18 SERIES

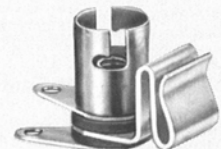

18-108-2-U

INSULATED

CANDELABRA SCREW LAMPS

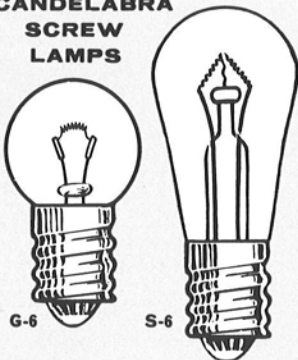

G-6

S-6

CANDELABRA SCREW SOCKETS

19 SERIES



19-50A

TWO LUGS

20 SERIES

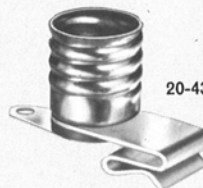

20-430-D

GROUNDED

21 SERIES



21-105-U

INSULATED

Above sockets using candela screw base shell Part #5053

FOR MOUNTING BRACKETS SEE PAGES 12-13-14-15



ASSEMBLIES

WITH SOLDERING LUGS

FOR LOW VOLTAGE INCANDESCENT LAMPS 6 TO 28V

SOCKETS WITH QUICK DISCONNECT TERMINALS

187 SERIES

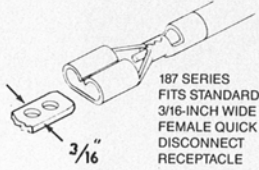

187 SERIES
FITS STANDARD
3/16-INCH WIDE
FEMALE QUICK
DISCONNECT
RECEPTACLE

3/16"

Quick Disconnect Terminals

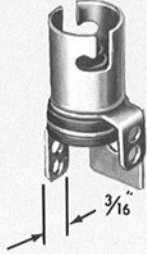

3/16"

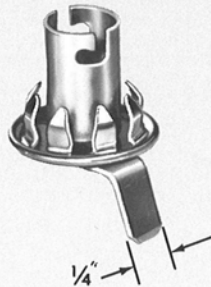

1/4"

Quick Disconnect Terminals

250 SERIES

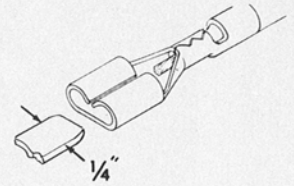

1/4"

250 SERIES
FITS STANDARD
1/4-INCH WIDE
FEMALE QUICK
DISCONNECT
RECEPTACLE

MINIATURE LAMPHOLDERS FOR PRINTED CIRCUIT BOARDS

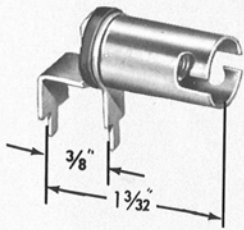

PC13-508

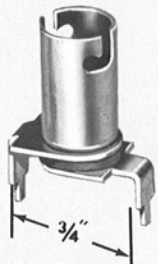

PC13-365-D

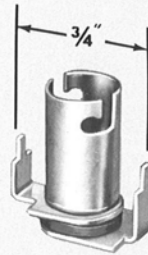

PC13-529-U

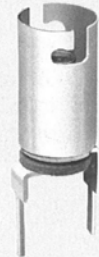

PC13-530-D

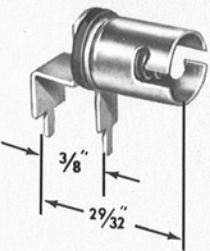

PC16-508

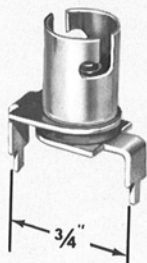

PC16-365-D

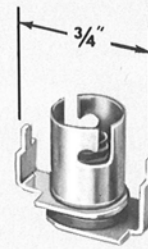

PC16-529-U



PC16-530-D

AVAILABLE IN THE 10 SERIES, 19 SERIES AND 22 SERIES

SINGLE CONTACT CANDELABRA BAYONET SOCKETS

22 SERIES

23 SERIES

24 SERIES

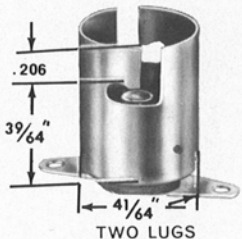

22-50A

TWO LUGS

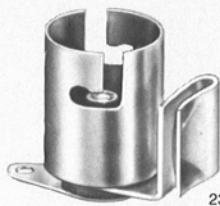

23-449-U

GROUNDED

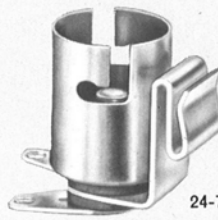

24-723-U

INSULATED

CANDELABRA
SINGLE CONTACT
BAYONET BASE



G-6

Above sockets using single contact candelabra bayonet base shell Part #5015

FOR MOUNTING BRACKETS SEE PAGES 12-13-14-15.



MOUNTING BRACKETS

SPECIAL LAMPHOLDERS

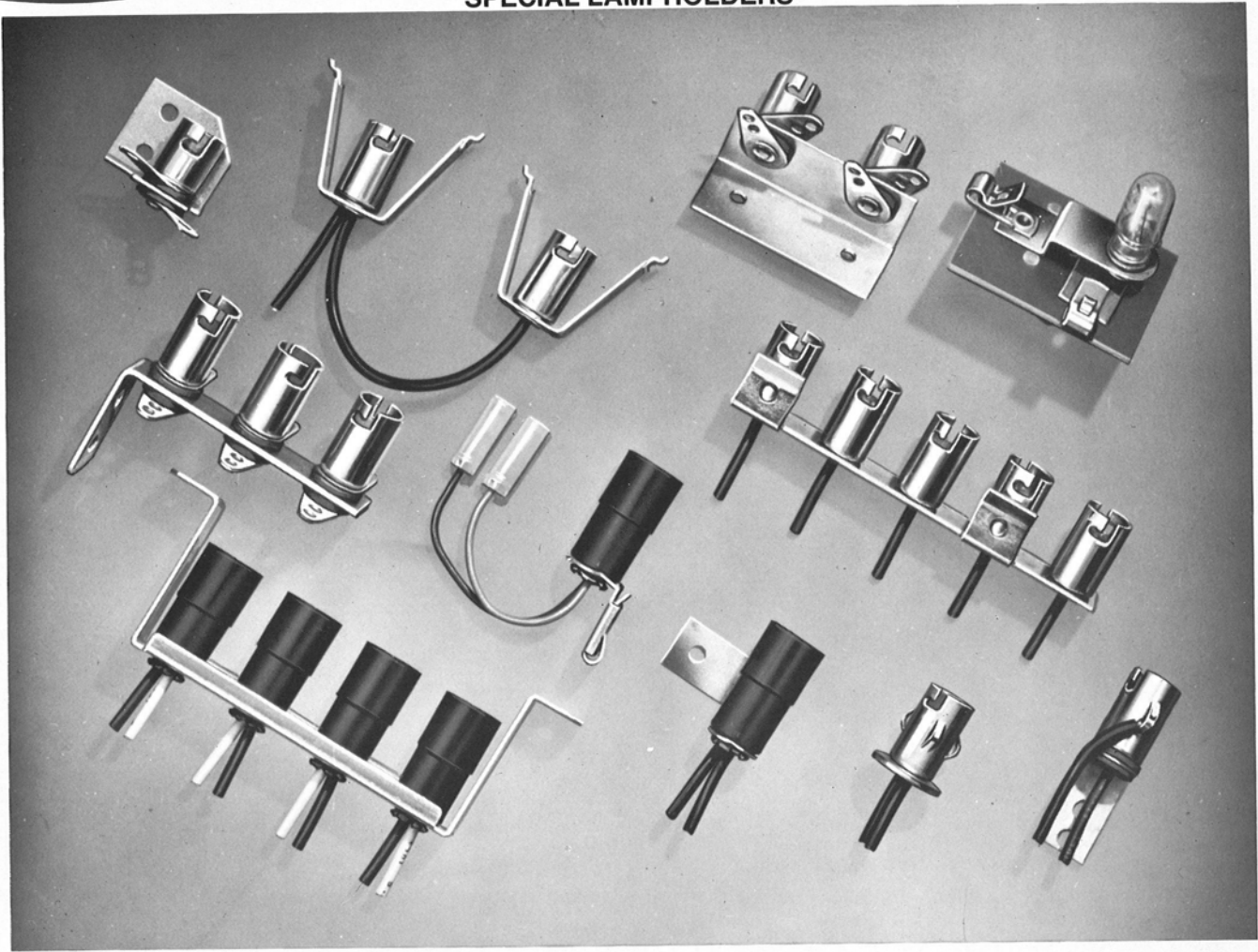

MOUNTING BRACKETS FOR CANDELABRA BAYONET ASSEMBLIES

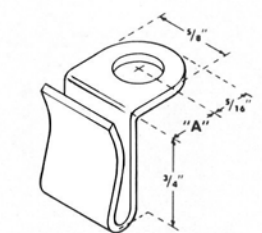
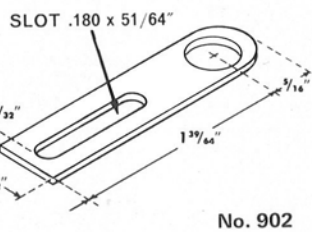
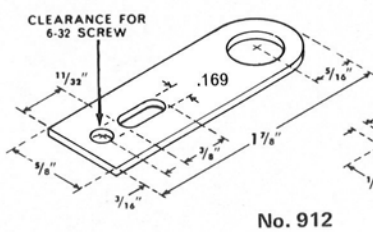
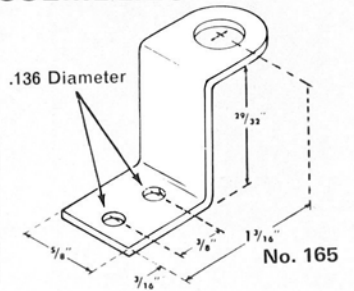
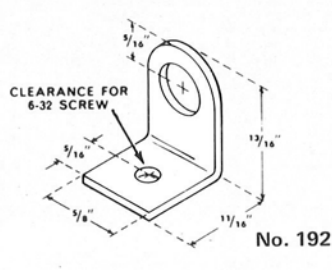
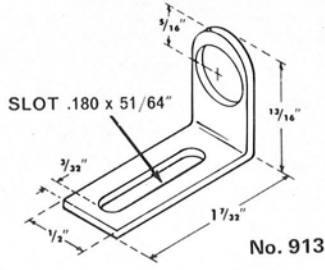
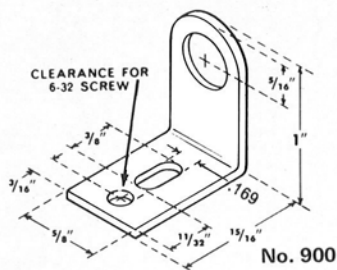

BRACKET NO.	DIM. "A"
190	3/8"
903	1/2"
191	1-3/8"

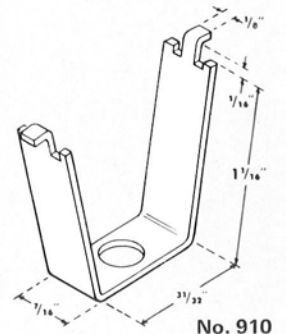

ALL AVAILABLE BRACKETS NOT SHOWN

MOUNTING BRACKETS



MOUNTING BRACKETS FOR MINIATURE BAYONET AND SCREW BASE ASSEMBLIES

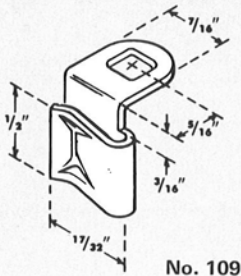

No. 109

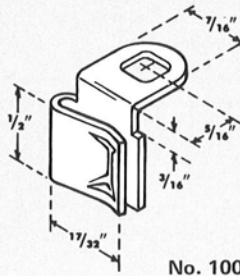

No. 100

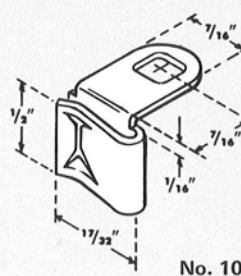

No. 106

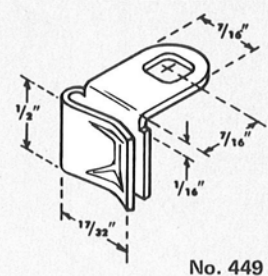

No. 449

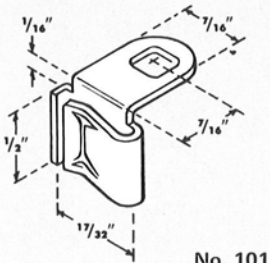

No. 101

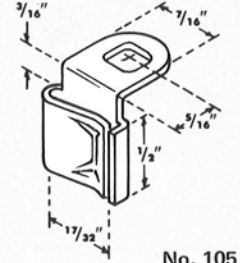

No. 105

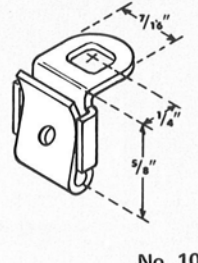

No. 102

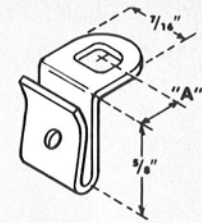

BRACKET NO.	DIM. "A"
104	1/4"
586	3/8"
198	1/2"

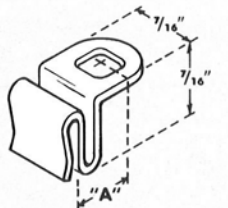

BRACKET NO.	DIM. "A"
108-2	13/32"
108-4	5/8"
108-8	1-3/32"

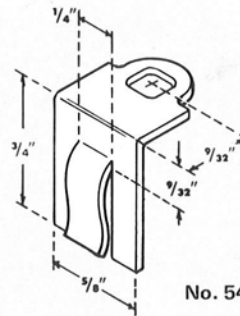

No. 546

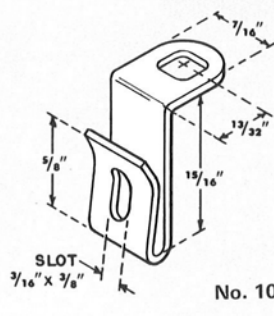

No. 107

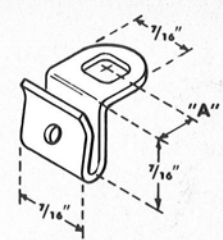

BRACKET NO.	DIM. "A"
66-4	9/32"
109-10	1-3/16"

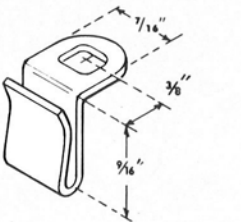

No. 196

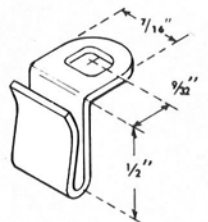

No. 563

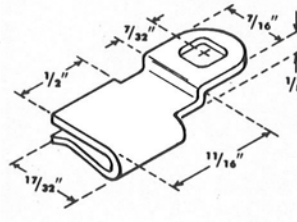

No. 100-F

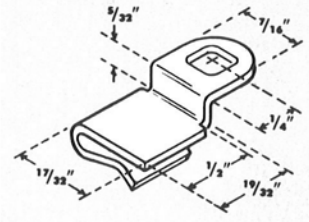

No. 106-F

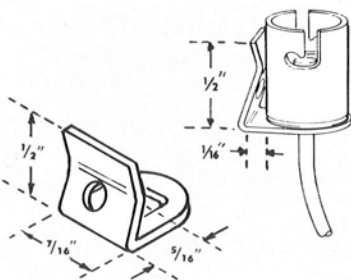

No. 438

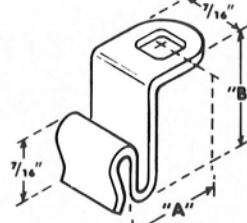

BRACKET NO.	DIM. "A"	DIM. "B"
723	7/16"	3/4"
647	7/16"	1"
344	3/8"	1-5/32"

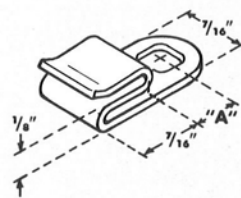

BRACKET NO.	DIM. "A"
430	7/32"
431	1"

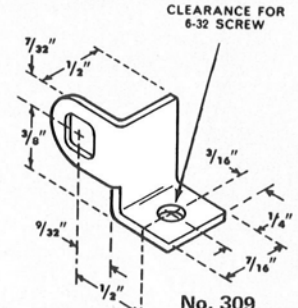

No. 309

ALL AVAILABLE BRACKETS NOT SHOWN



MOUNTING BRACKETS

MOUNTING BRACKETS FOR MINIATURE BAYONET AND SCREW BASE ASSEMBLIES

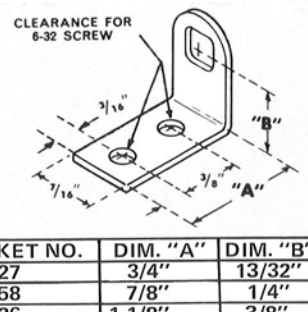
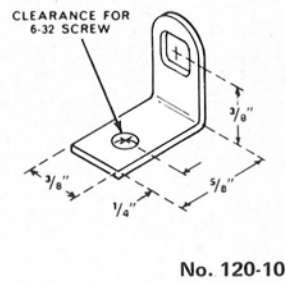
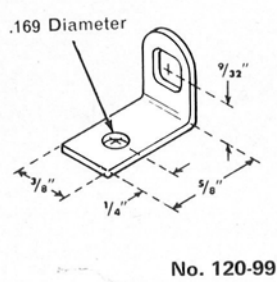
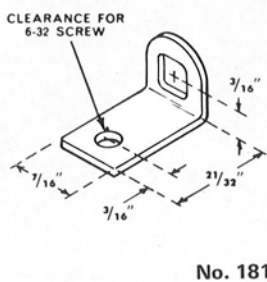
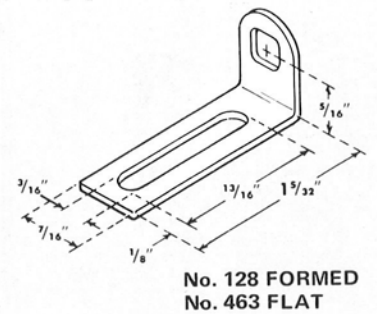
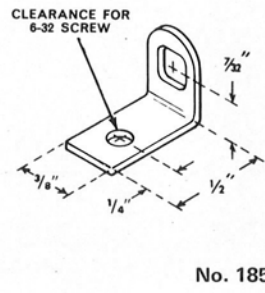
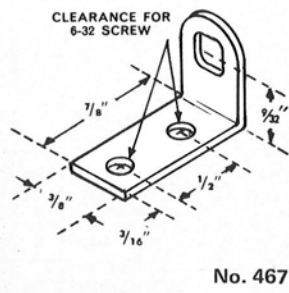
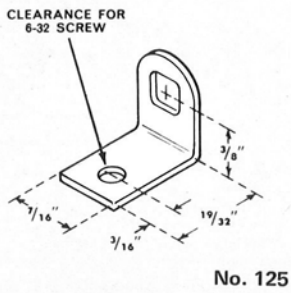
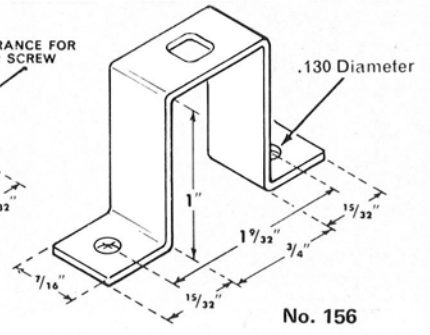
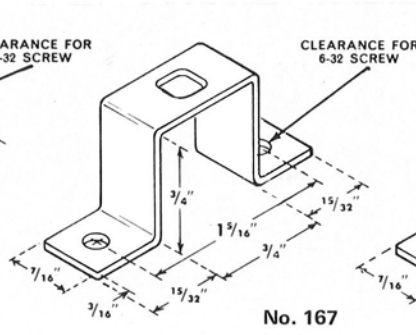
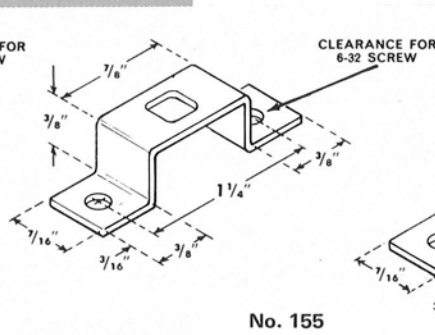
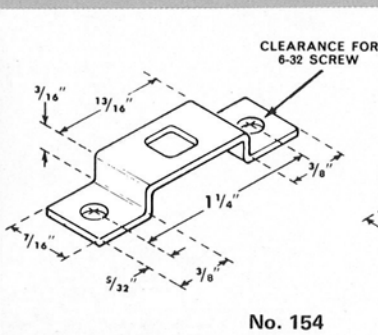
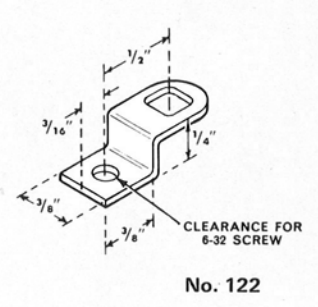
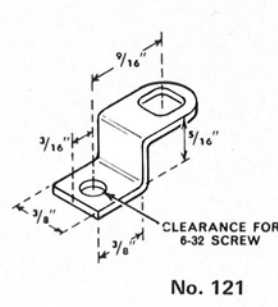
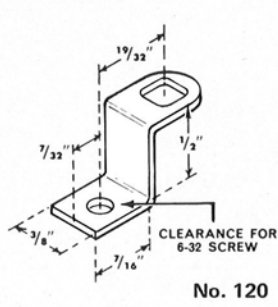
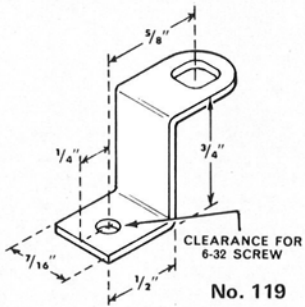
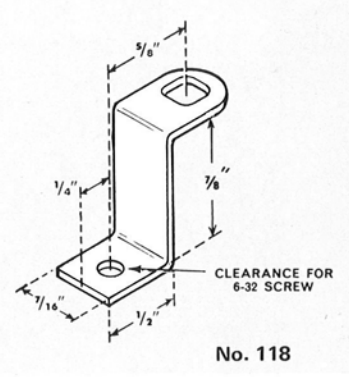
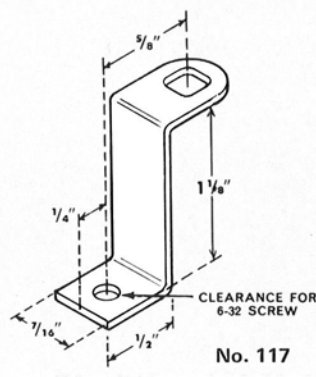
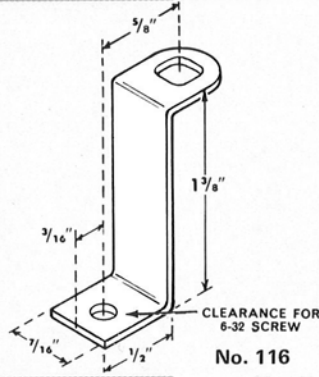
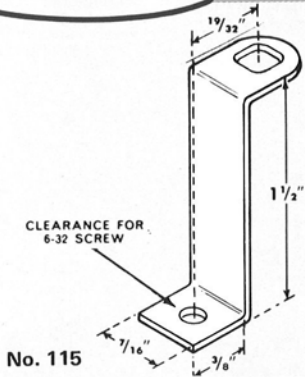

BRACKET NO.	DIM. "A"	DIM. "B"
127	3/4"	13/32"
258	7/8"	1/4"
126	1-1/8"	3/8"

ALL AVAILABLE BRACKETS NOT SHOWN

MOUNTING BRACKETS

MOUNTING BRACKETS FOR MINIATURE BAYONET AND SCREW BASE ASSEMBLIES



BRACKET NO.	DIM. "A"
141	7/16"
142	9/16"
143	5/8"
146	11/16"
144	3/4"
147	25/32"
162	13/16"
145	29/32"

BRACKET NO.	DIM. "A"
169	1-1/32"
149	1-1/8"
150	1-3/16"
151	1-1/4"
152	1-5/16"
153	1-3/8"
164	1-7/16"
171	1-9/16"
173	1-13/16"

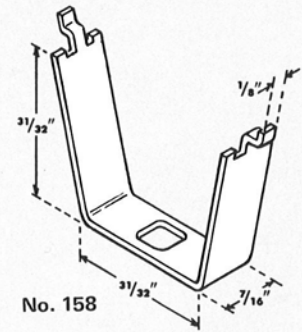
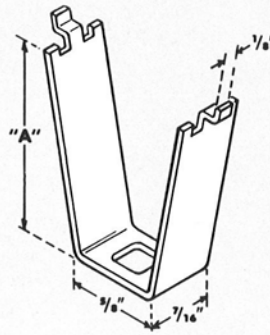

No. 158

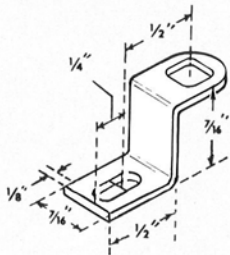

1/8" x 1/4" SLOT

No. 208

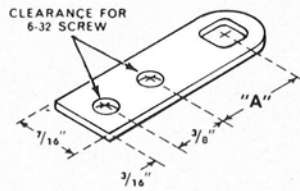

BRACKET NO.	DIM. "A"
758	19/32"
760	15/16"

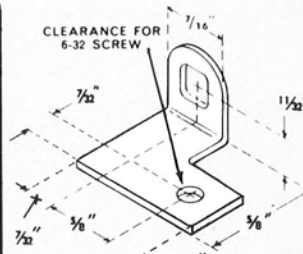

No. 712

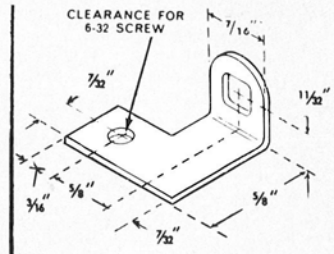

No. 711

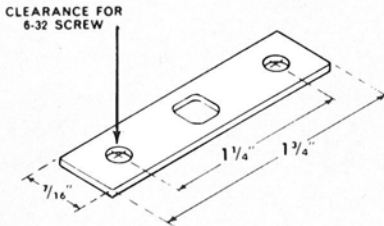

No. 521

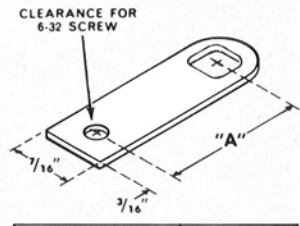

BRACKET NO.	DIM. "A"
520	3/4"
403	31/32"
283	11/16"

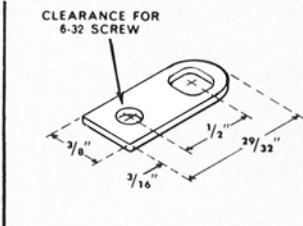

No. 130

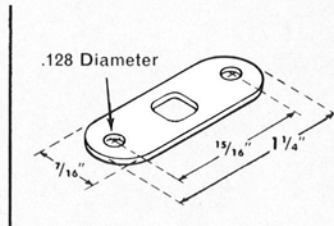

No. 813

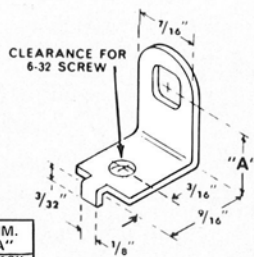

BRACKET NO.	DIM. "A"
657	5/16"
303	7/16"
410	1/4"
259	9/32"

No. 129

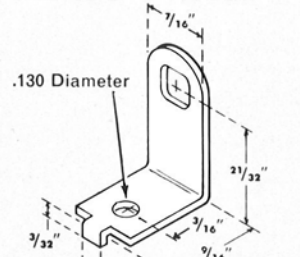

No. 516

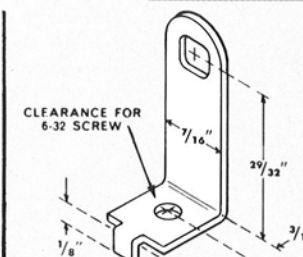

No. 898

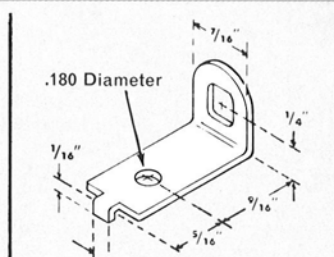

No. 512

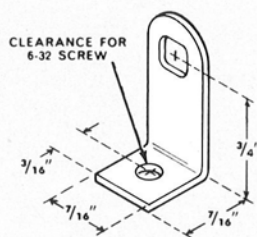

No. 131

No. 129

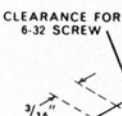
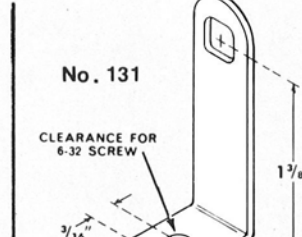

No. 131

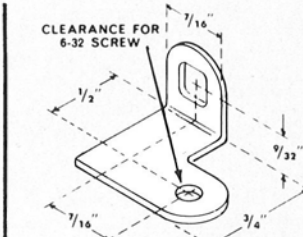

No. 157-AR

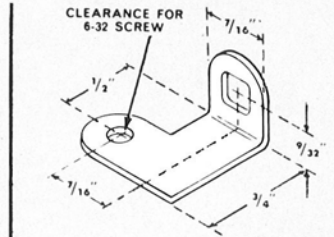

No. 157-AL

ALL AVAILABLE BRACKETS NOT SHOWN

Terminal Board ASSEMBLIES



A variety of terminals and other hardware mounted on laminated plastic materials. Laminates and hardware styles to meet all Military and Commercial Specifications.

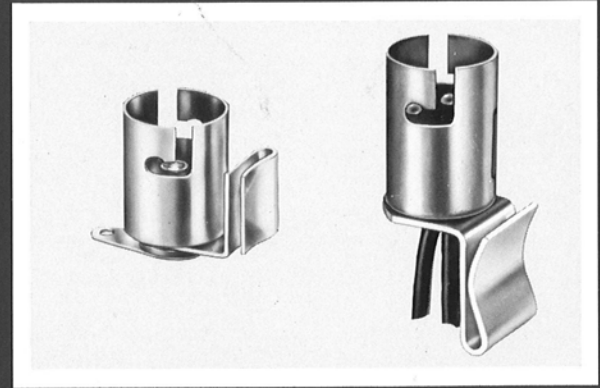
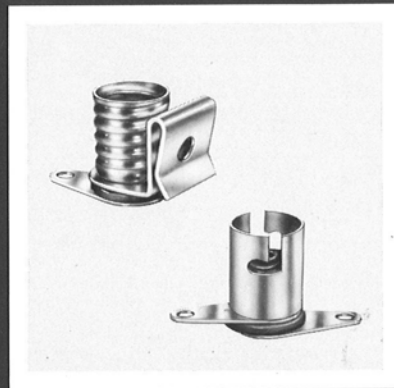
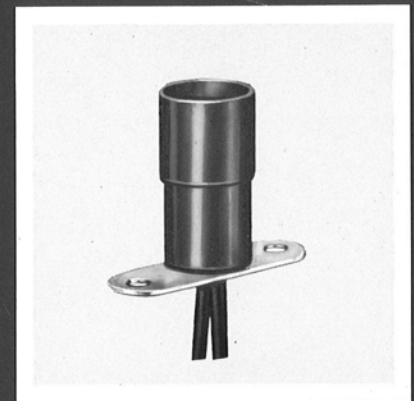
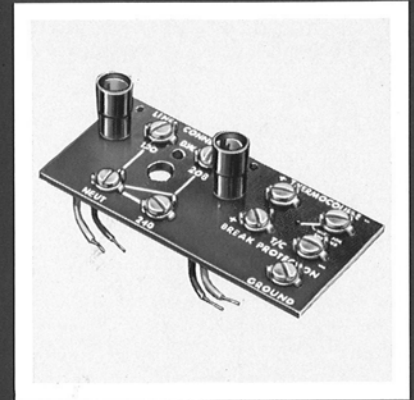
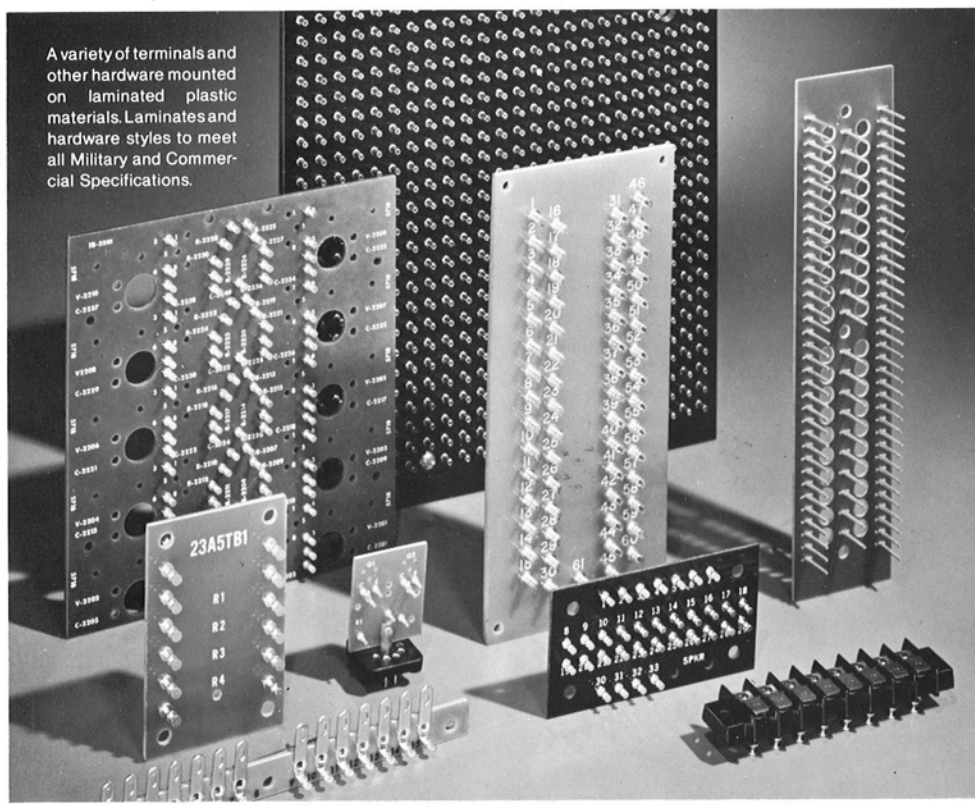

MINIATURE LAMPHOLDERS

AERONAUTICAL ELECTRIC COMPANY



Electronic Components

division of ACO, Inc.

5656 NORTHWEST HIGHWAY, CHICAGO, IL 60646
PHONE 773 774-5200